Front Door Window Glass Adjustment

Special Tool(s) / General Equipment

Flat Headed Screw Driver

Adjustment

NOTE: Left hand (LH) shown, right hand (RH) similar.

NOTE: Removal steps in this procedure may contain installation details.

All adjustments

1. **NOTE:** This step is only necessary when the door has been replaced.

NOTE: The front door must be aligned correctly before adjusting the front door window glass.

Check the front door alignment.

Refer to: [Front Door Alignment](#) (501-03 Body Closures, General Procedures).

Up/Down, Forward/Rearward adjustment

2. **NOTE:** See the illustration for where to measure. The tape placement at the top edge does not matter. It is a reference point in which the engagement of the glass to the weatherstrip seal is subtracted.

Apply tape to top of the front door window glass at the specified locations.

1. Apply tape on front door window glass at the B-pillar 80 mm (3.149 in) from the rear top edge of the front door window glass and make a reference mark on the tape to take measurements from.
2. Apply tape on front door window glass at the A-pillar 80 mm (3.149 in) from the front top edge of the front door window glass and make a reference mark on the tape to take measurements from.
3. Apply tape on front door window glass at the A-pillar 40 mm (1.574 in) down from the front top edge of the front door window glass and make a reference mark on the tape to take measurements from.
4. Apply tape on front door window glass measuring from the bottom of front door window glass at the top of the front door window glass filler panel up 170 mm (6.692 in) toward the roof line and make a reference mark on the tape to take measurements from.

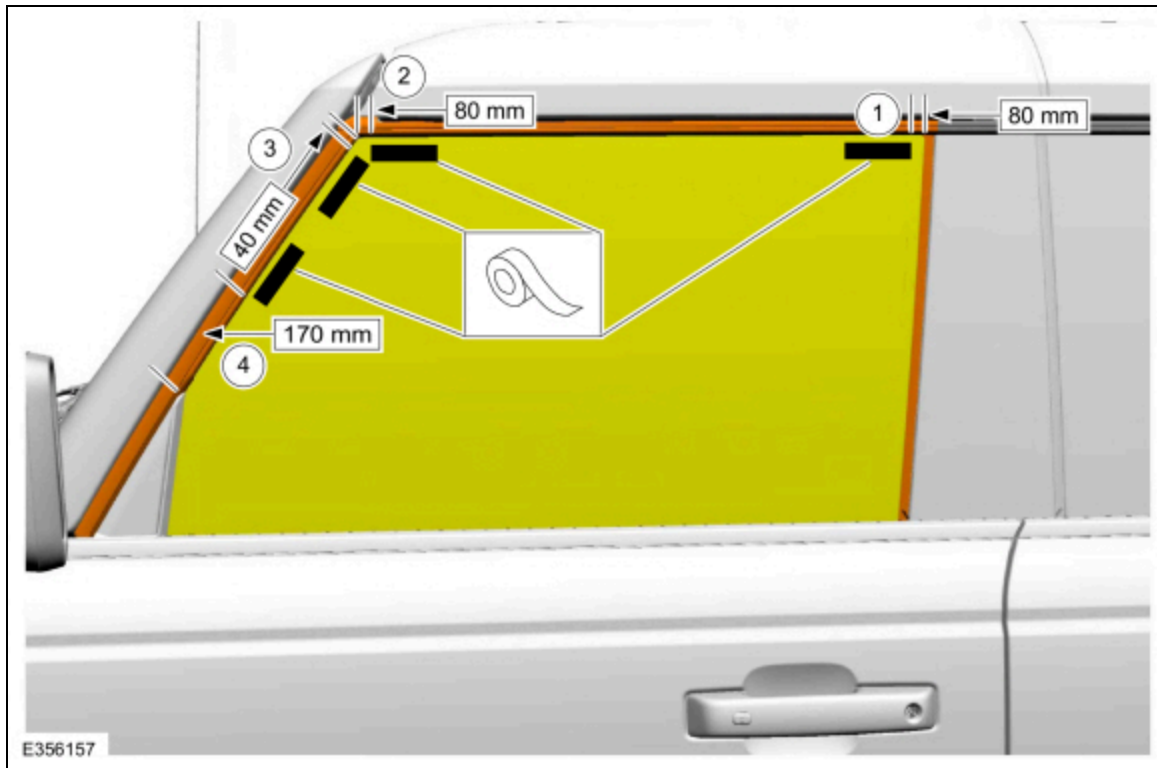

3. Open the front door.

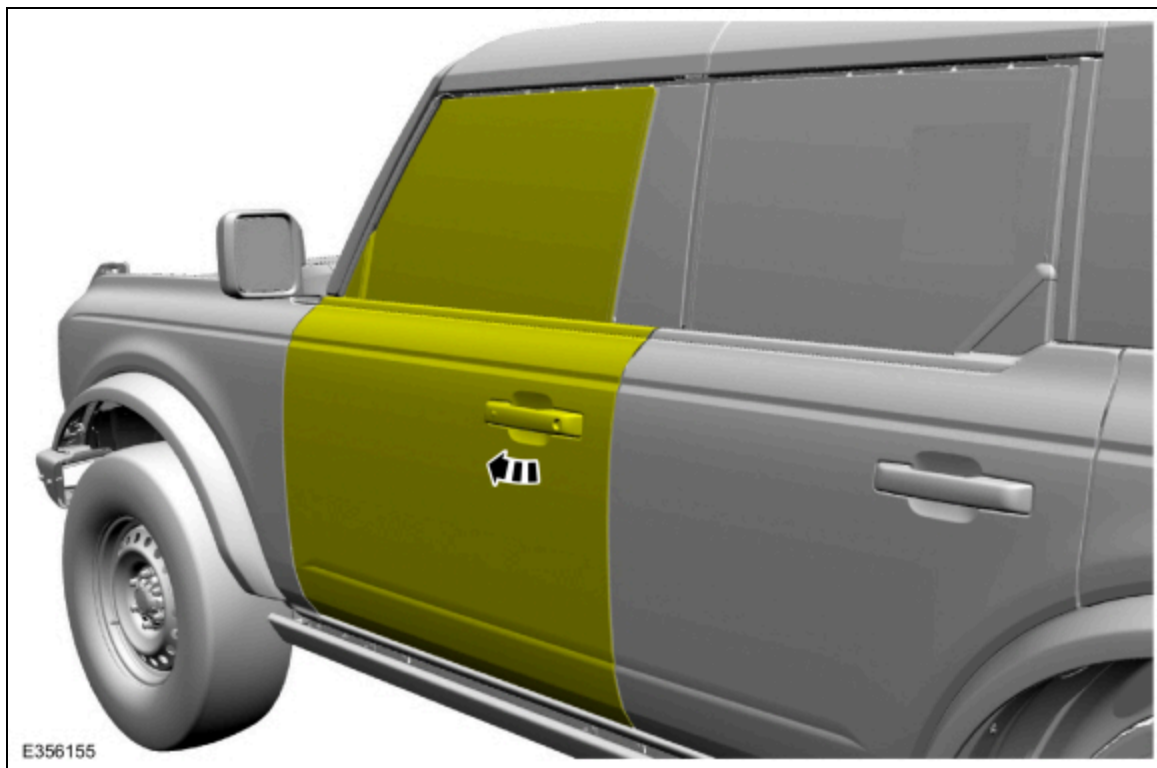

4. Measure the distance of the marks on the tape at all locations to the top edge of the front door window glass at the specified locations.
1. Measure the front door window glass at the B-pillar 80 mm (3.149 in) from the rear top edge of the front door window glass and record.
 2. Measure the front door window glass at the A-pillar 80 mm (3.149 in) from the front top edge of the front door window glass and record.
 3. Measure the front door window glass at the A-pillar 40 mm (1.574 in) down from the front top edge of the front door window glass and record.

4. Measure the front door window glass from at the 170 mm (6.692 in) mark from the front top edge of the front door window glass and record.

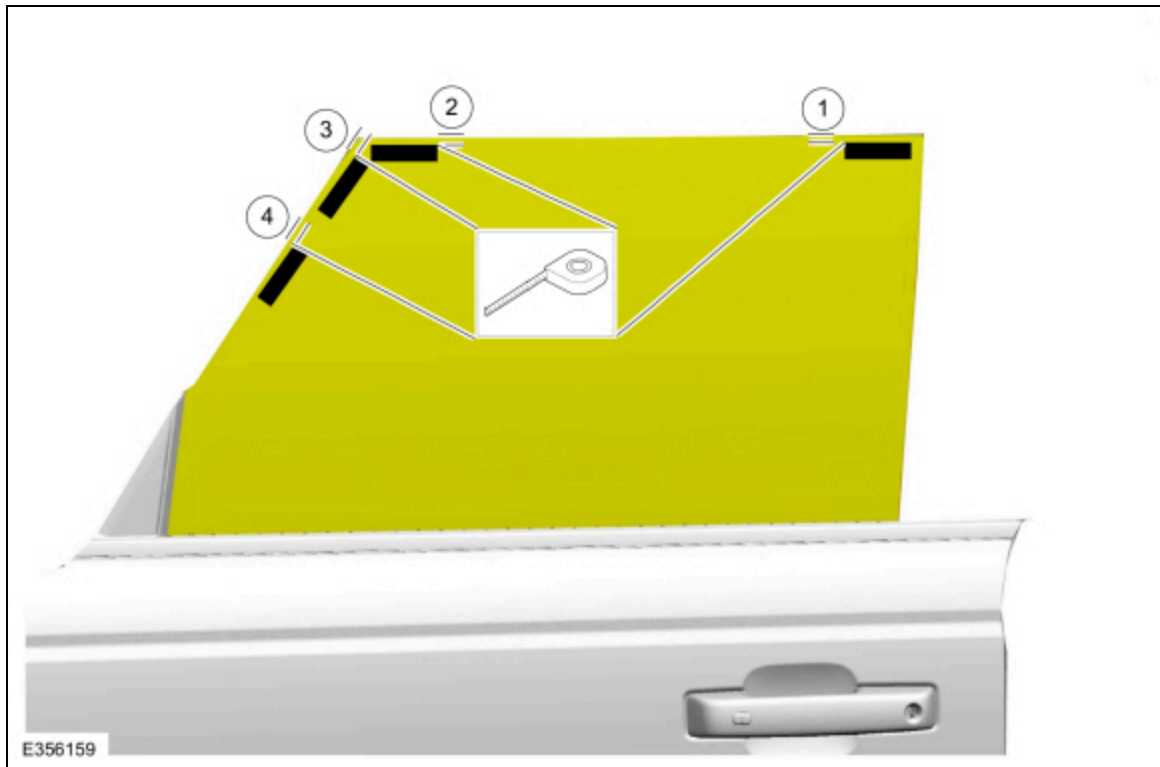

5. Close the front door.

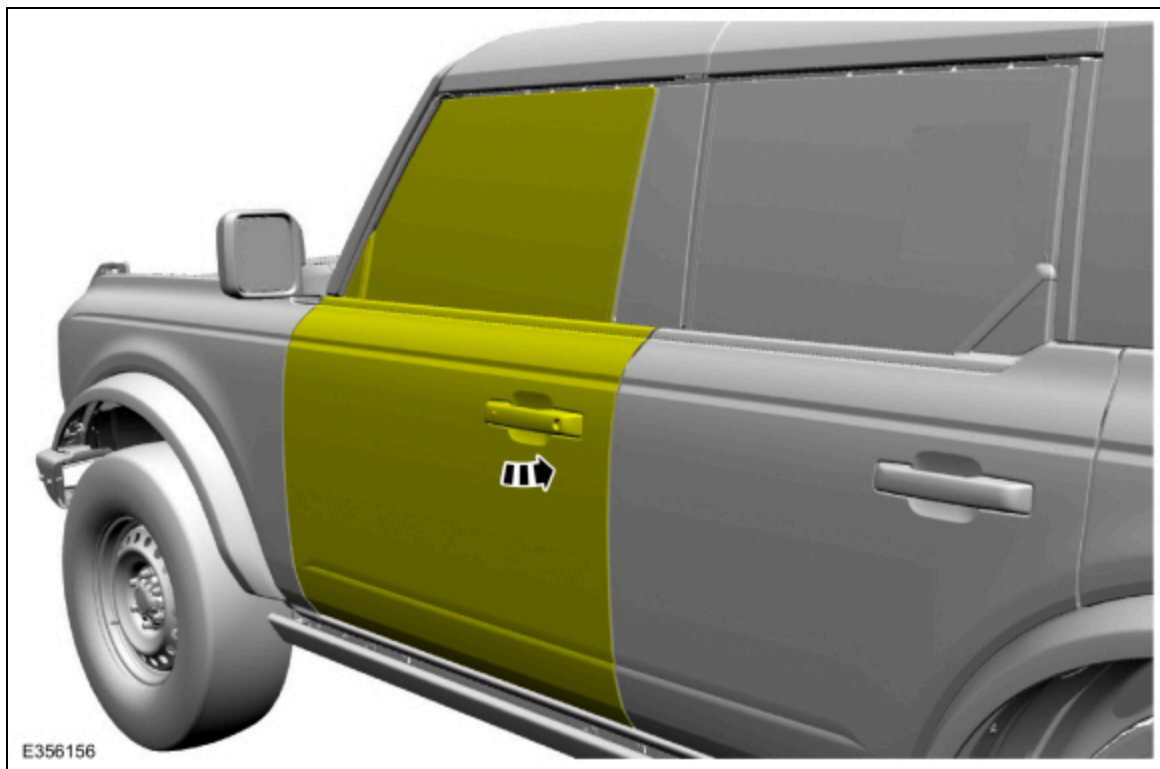

6. Measure the distance of the marks on the tape at all locations to the outer bottom edge of the seal retainer at the specified locations.

1. Measure the front door window glass at the B-pillar 80 mm (3.149 in) from the rear top edge of the front door window glass and record.
2. Measure the front door window glass at the A-pillar 80 mm (3.149 in) from the front top edge of the front door window glass and record.

3. Measure the front door window glass at the A-pillar 40 mm (1.574 in) down from the front top edge of the front door window glass and record.
4. Measure the front door window glass at the 170 mm (6.692 in) mark from the front top edge of the front door window glass and record.

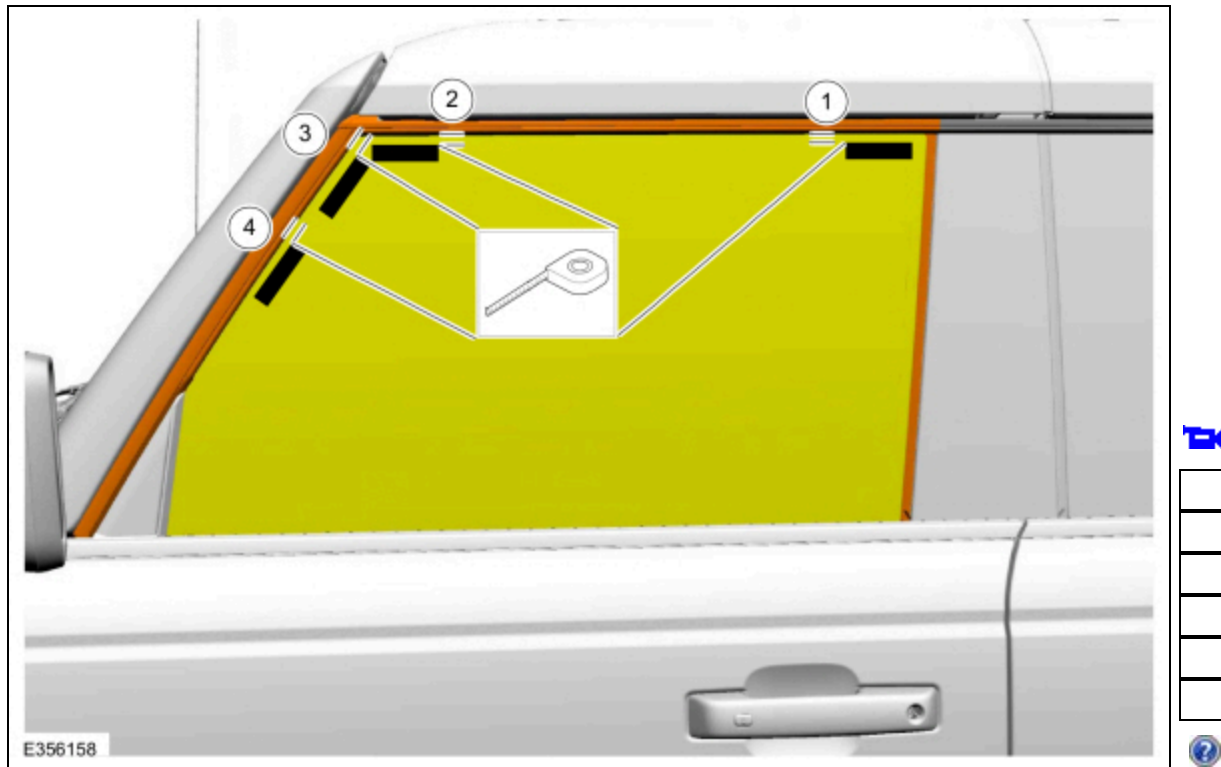

7. Subtract the distance of the marks on the tape at all locations from the previously recorded measurements in step 4.
 1. Front door window glass engagement measurement range at the B-pillar 80 mm (3.149 in) from the rear top edge of the front door window glass range is 3 mm (0.118 in) +/- 2 mm (0.078 in).
 2. Front door window glass engagement measurement range at A-pillar 80 mm (3.149 in) from the front top edge of the front door window glass range is 3 mm (0.118 in) +/- 2 mm (0.078 in).
 3. Front door window glass engagement measurement range at the A-pillar 40 mm (1.574 in) down from the front top edge of the front door window glass range is 4 mm (0.157 in) +/- 2 mm (0.078 in).
 4. Front door window glass engagement measurement range at the 170 mm (6.692 in) range is 4 mm (0.157 in) +/- 2 mm (0.078 in).
8. Open the front door.

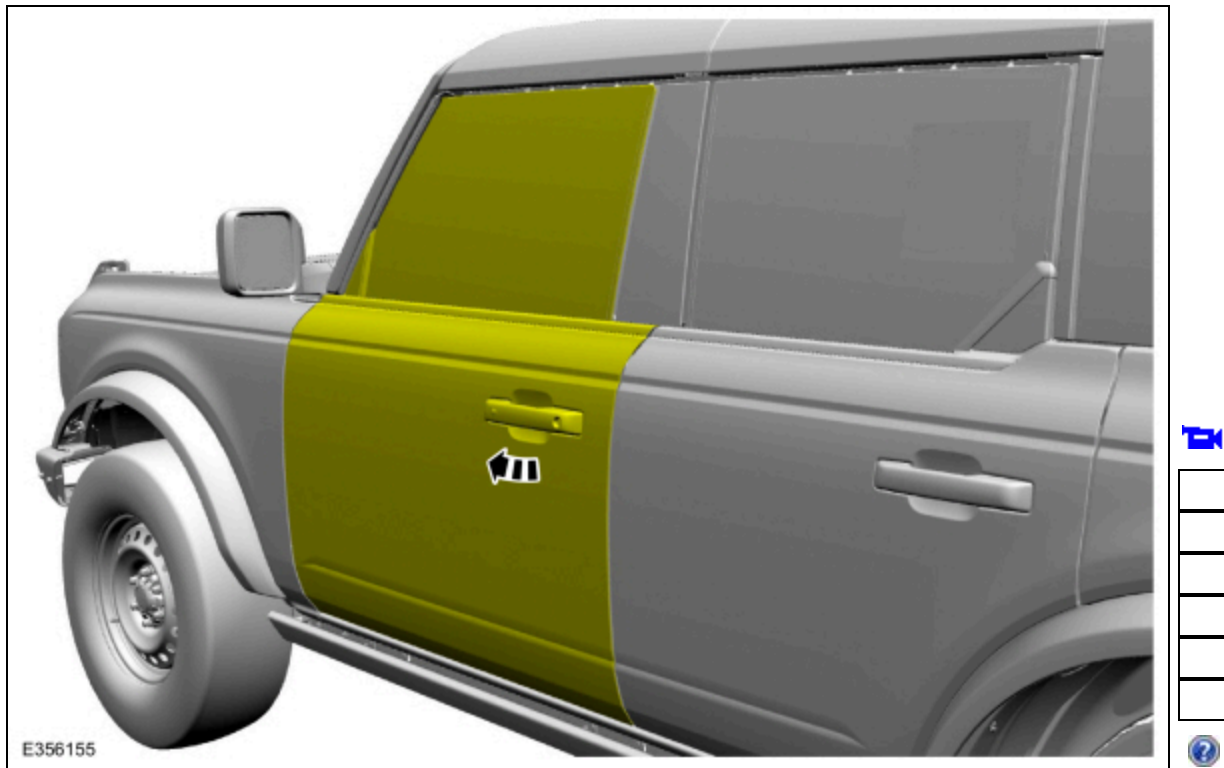

9. Remove the front door trim panel.
Refer to: [Front Door Trim Panel](#) (501-05 Interior Trim and Ornamentation, Removal and Installation).

10. **NOTE:** *The front door shown removed for clarity.*

Remove the front door window glass adhesive covers.

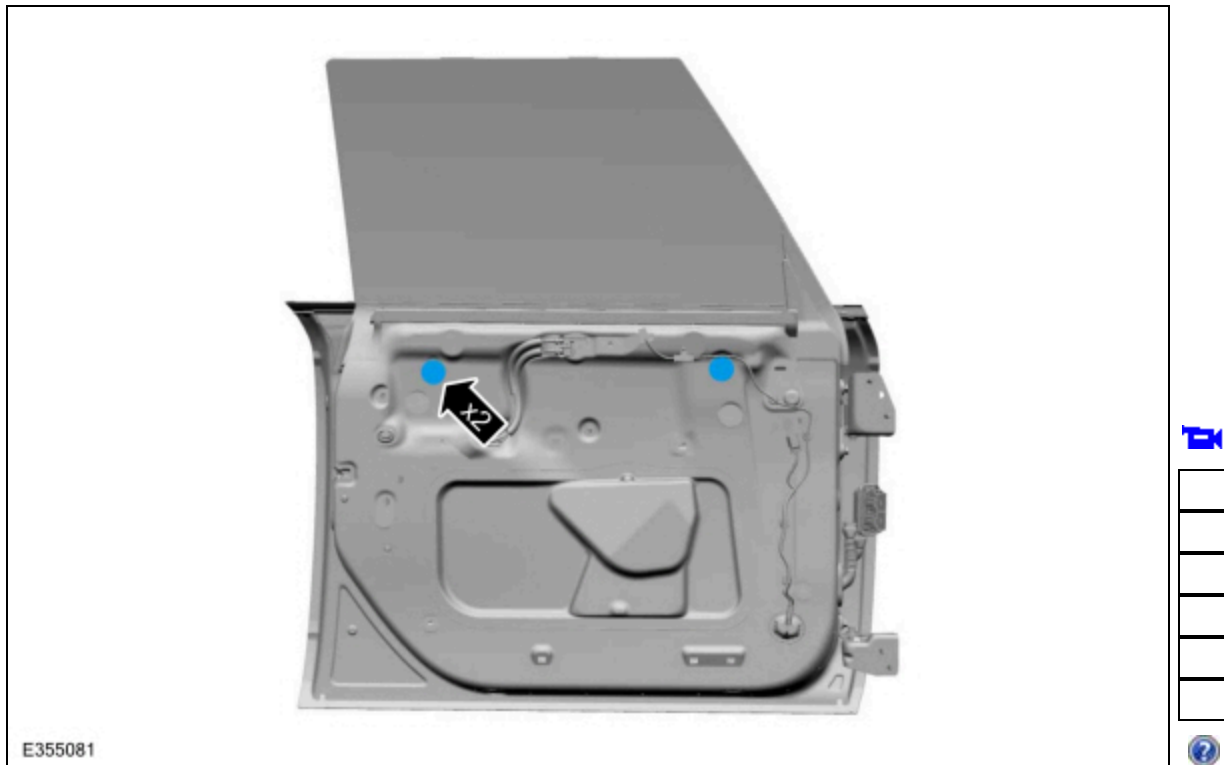

11. **NOTICE:** Make sure to release the front door latch to the open position before closing the front door.
Damage to the front door latch may occur.

NOTE: *The front door shown removed for clarity.*

Raise and align the front door window glass.

1. Position the front door latch in to the closed position and the front door window glass will raise to the full up position.
Use the General Equipment: Flat Headed Screw Driver
2. Confirm the front door window glass screws are aligned with the access openings.

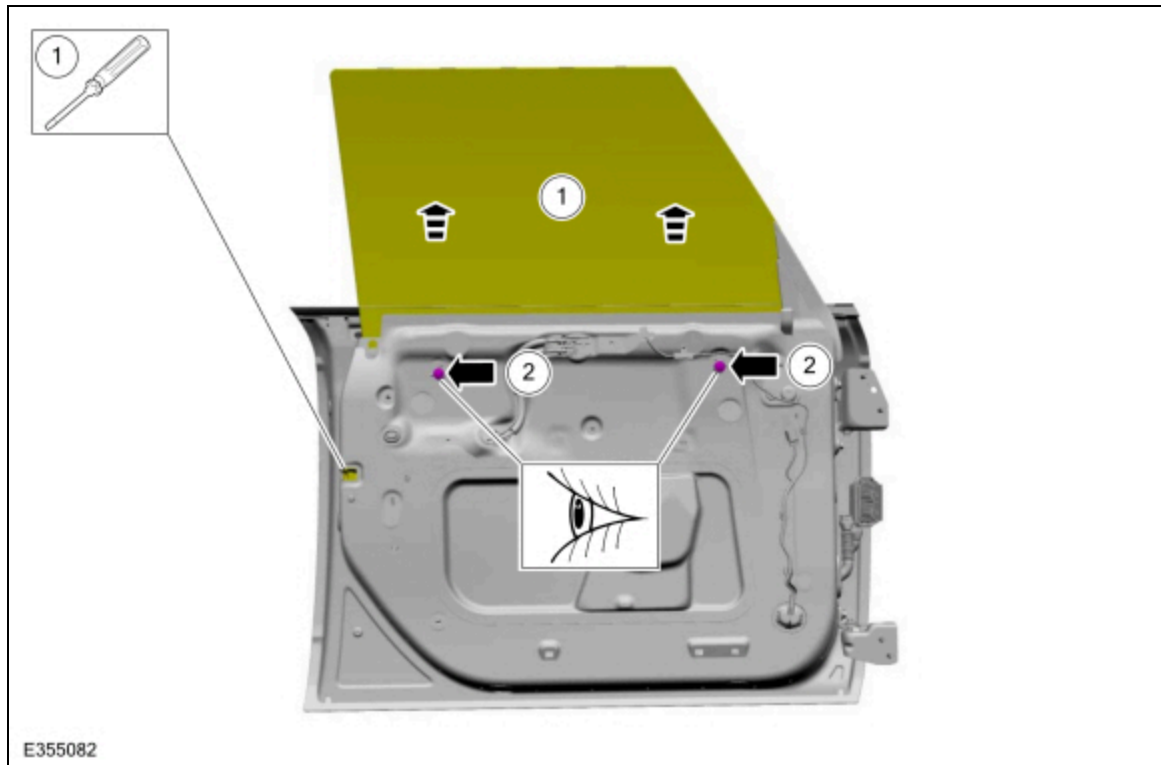

12. **NOTICE:** Make sure to release the front door latch to the open position before closing the front door. Damage to the front door latch may occur.

NOTE: The front door shown removed for clarity.

1. Loosen both front door window glass screws, adjust the front door window glass as necessary and tighten both front door window glass retainers.
Torque: 93 lb.in (10.5 Nm)
2. Position the front door latch in to the open position.
Use the General Equipment: Flat Headed Screw Driver

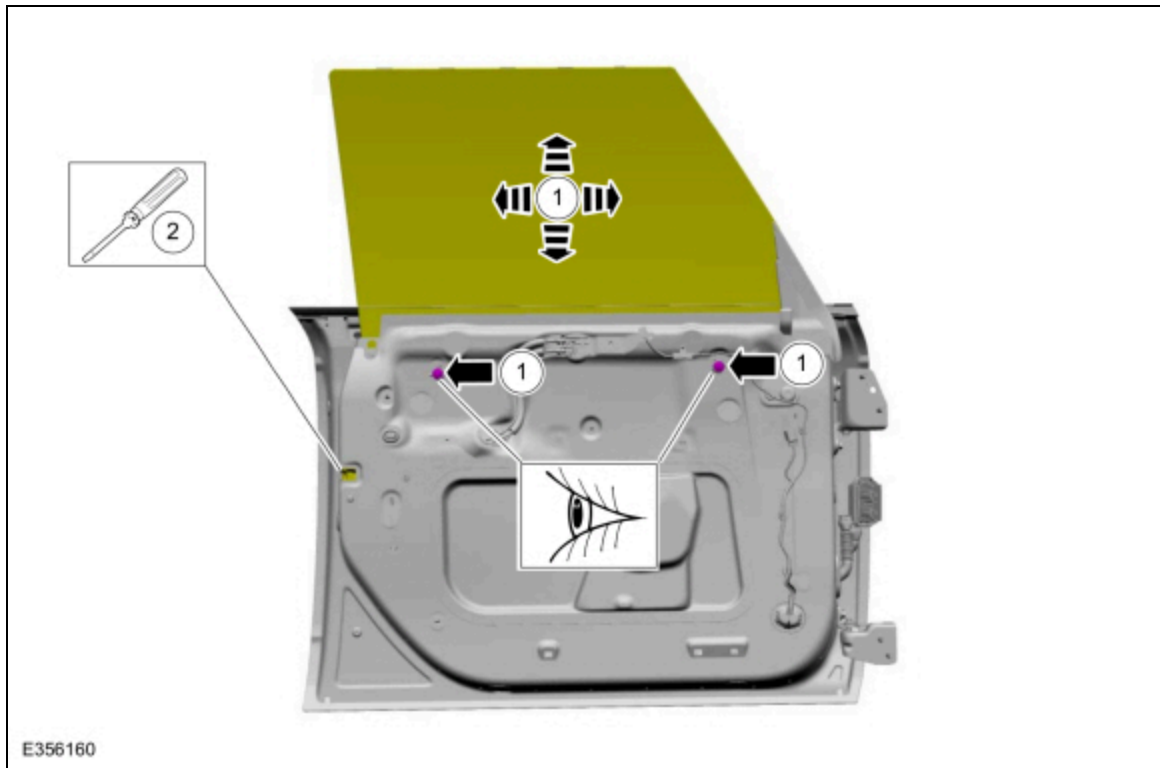

13. Close the front door.

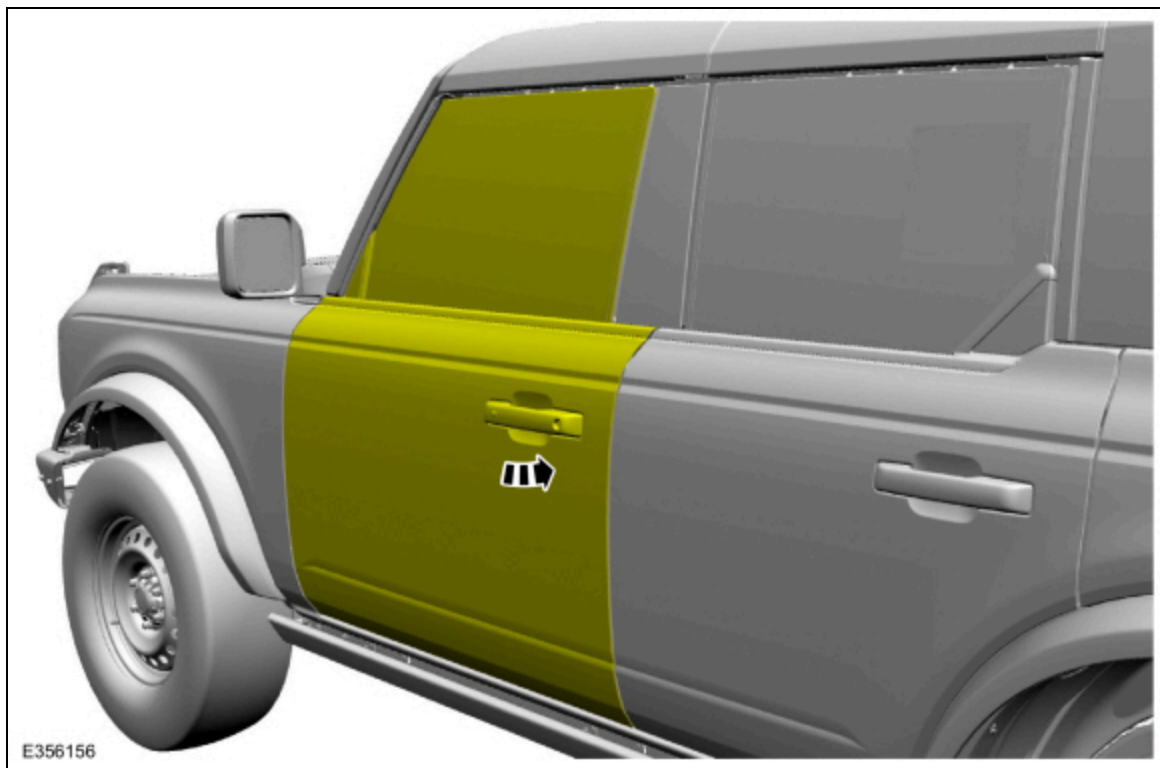

14. Measure the distance of the marks on the tape at all locations to the outer bottom edge of the seal retainer at the specified locations.
1. Measure the front door window glass at the B-pillar 80 mm (3.149 in) from the rear top edge of the front door window glass and record.
 2. Measure the front door window glass at the A-pillar 80 mm (3.149 in) from the front top edge of the front door window glass and record.
 3. Measure the front door window glass at the A-pillar 40 mm (1.574 in) down from the front top edge of the front door window glass and record.

4. Measure the front door window glass from at the 170 mm (6.692 in) mark from the front top edge of the front door window glass and record.

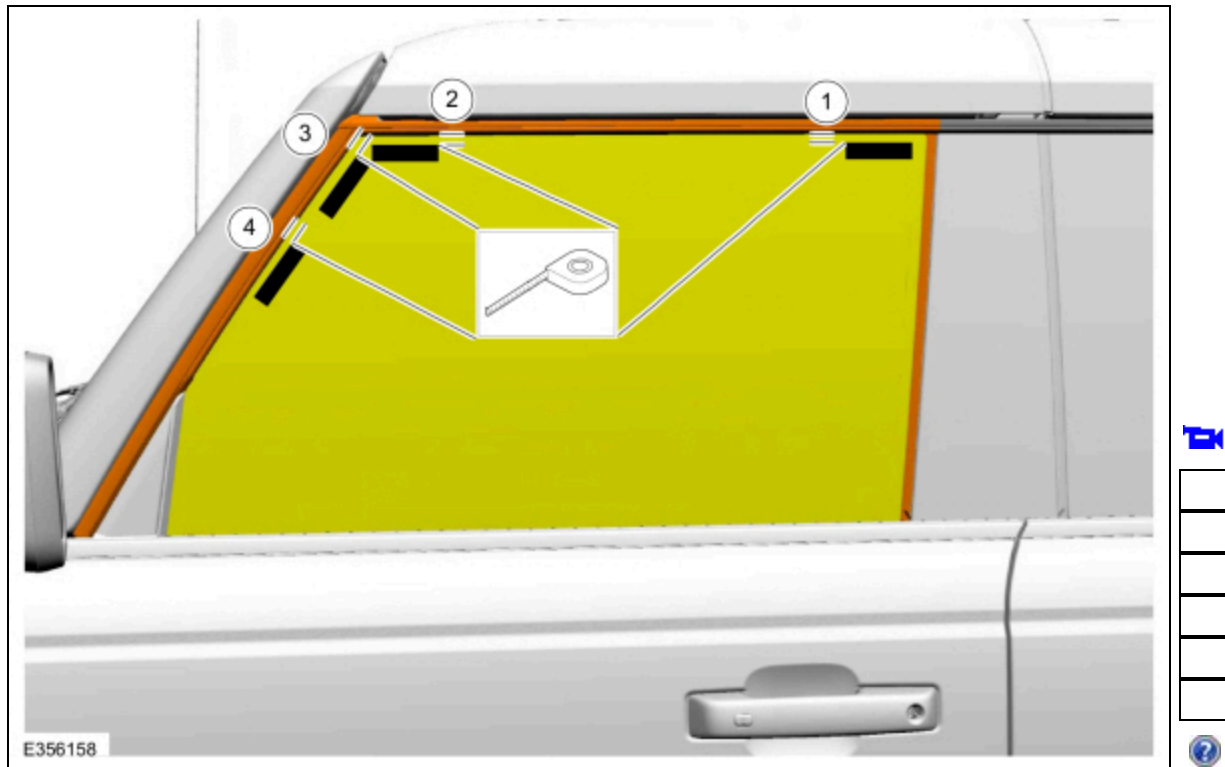

15. **NOTE:** Repeat steps 11 through 15 until the front door window glass within specification.

Subtract the distance of the marks on the tape at all locations from the previously recorded measurements in step 4.

1. Front door window glass engagement measurement range at the B-pillar 80 mm (3.149 in) from the rear top edge of the front door window glass range is 3 mm (0.118 in) +/- 2 mm (0.078 in).
2. Front door window glass engagement measurement range at A-pillar 80 mm (3.149 in) from the front top edge of the front door window glass range is 3 mm (0.118 in) +/- 2 mm (0.078 in).
3. Front door window glass engagement measurement range at the A-pillar 40 mm (1.574 in) down from the front top edge of the front door window glass range is 4 mm (0.157 in) +/- 2 mm (0.078 in).
4. Front door window glass engagement measurement range at the 170 mm (6.692 in) range is 4 mm (0.157 in) +/- 2 mm (0.0978 in).
5. Measure the front door window glass gap between the B-pillar and the rear edge of the front door window glass. When the glass is adjusted correctly the gap should be 10 mm (0.393 in) +/- 2.6 mm (0.102 in) the entire length of the rear edge of the front door window glass.

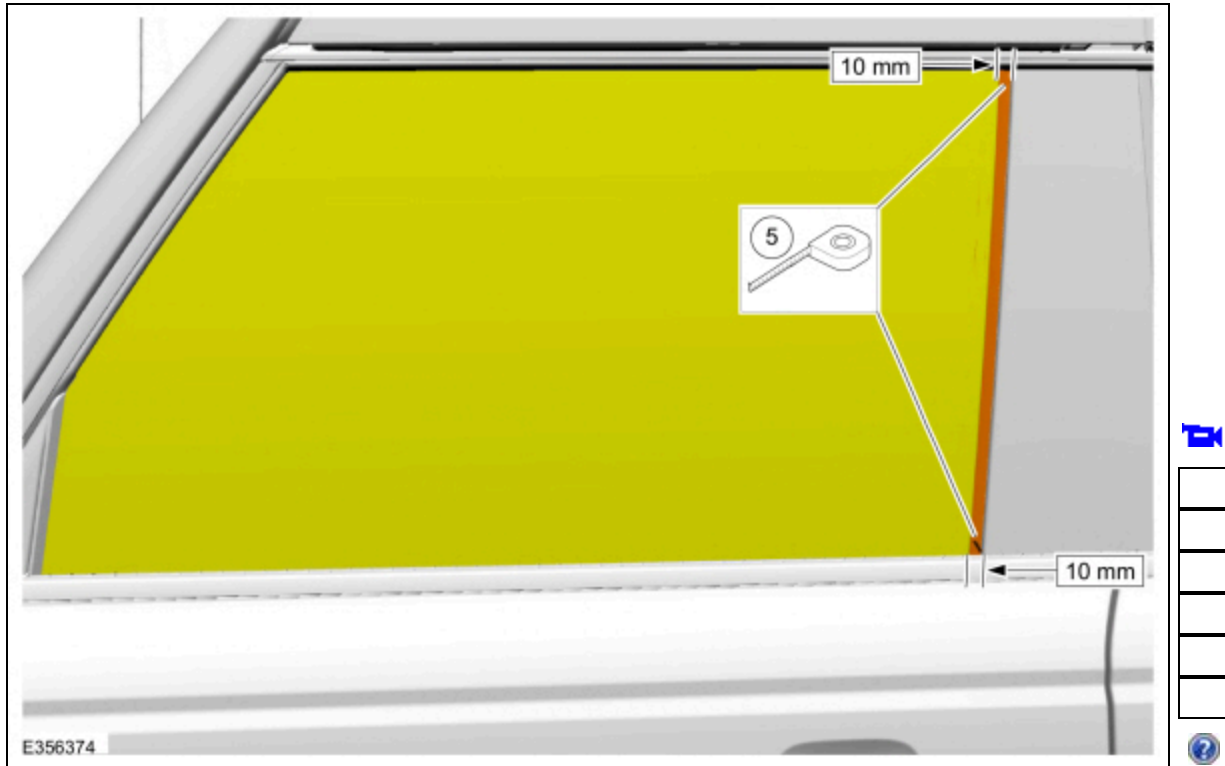

In/Out adjustment

- 16. Lower and raise the front door window glass and check the front door window glass engagement into the weatherstrip at the specified locations.

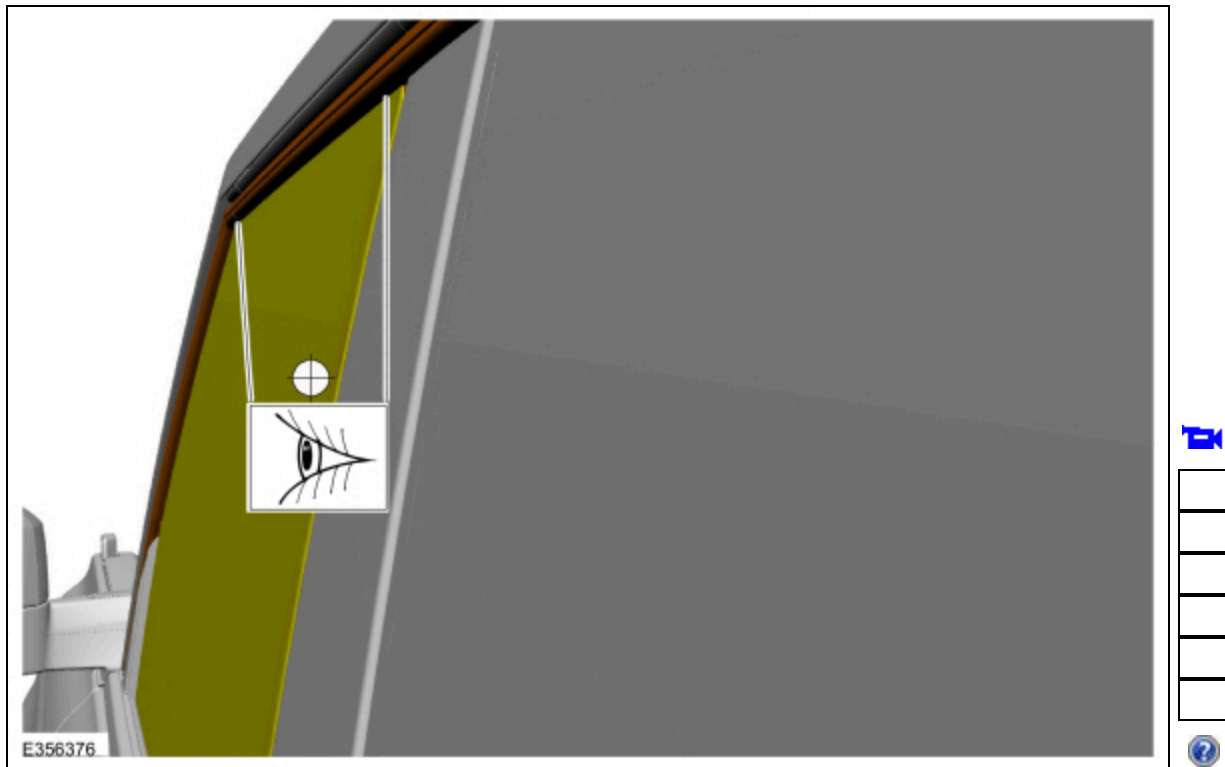

- 17. Open the front door.

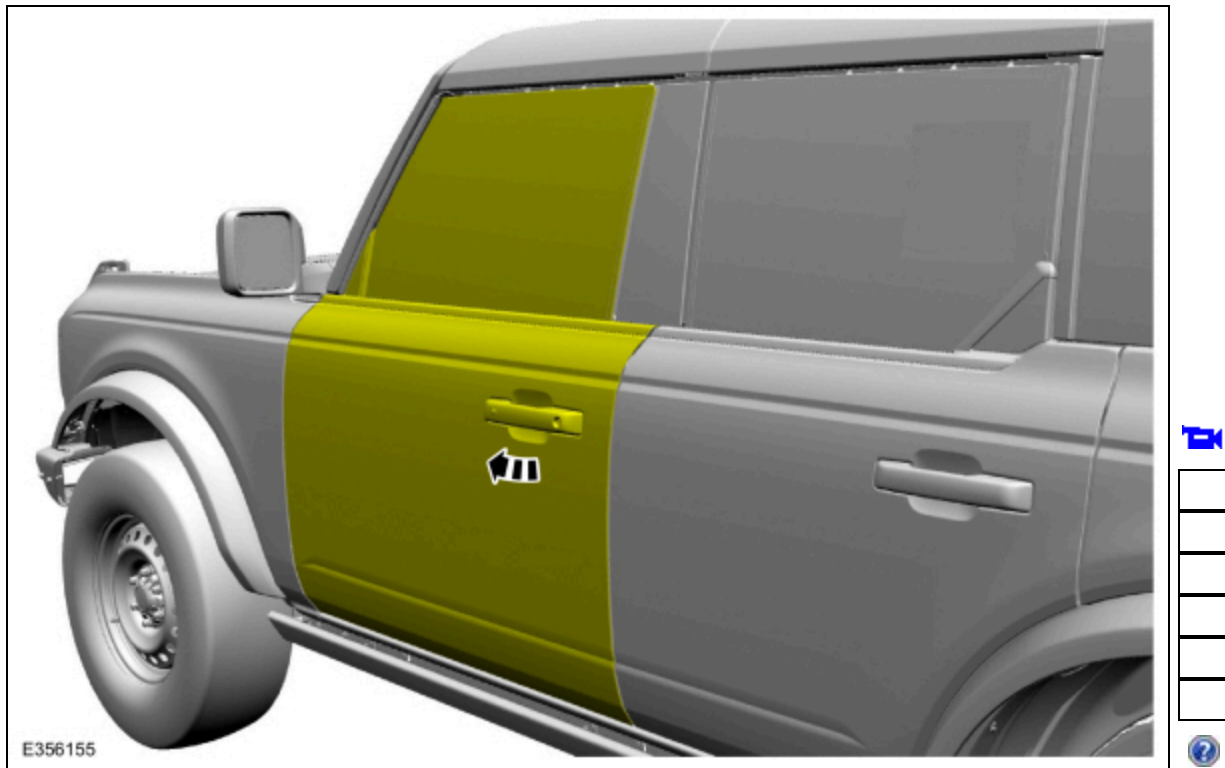

18. **NOTE:** *The front door shown removed for clarity.*

Remove the lower front door window regulator access plugs.

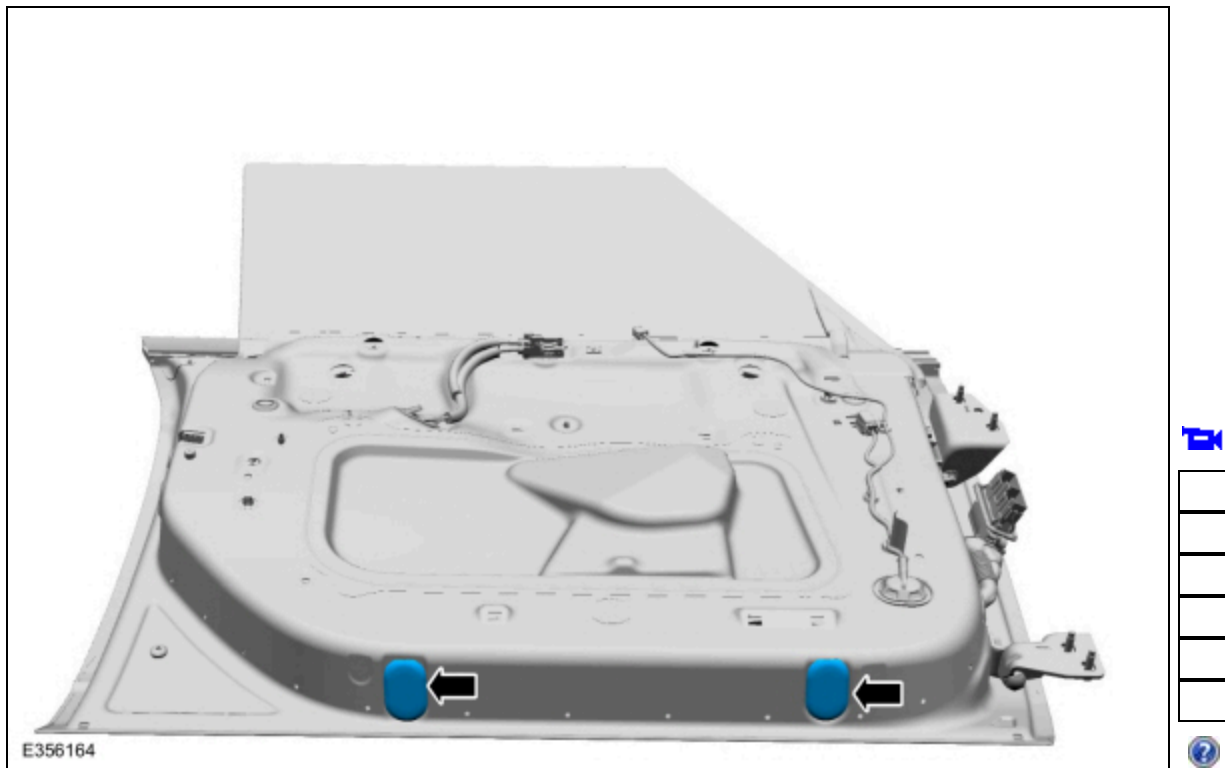

19. **NOTE:** *The front door shown removed for clarity.*

Remove the rearward front door glass run and bracket access plug.



20. **NOTE:** *The front door shown removed for clarity.*

Remove the forward front door glass run and bracket access plug.

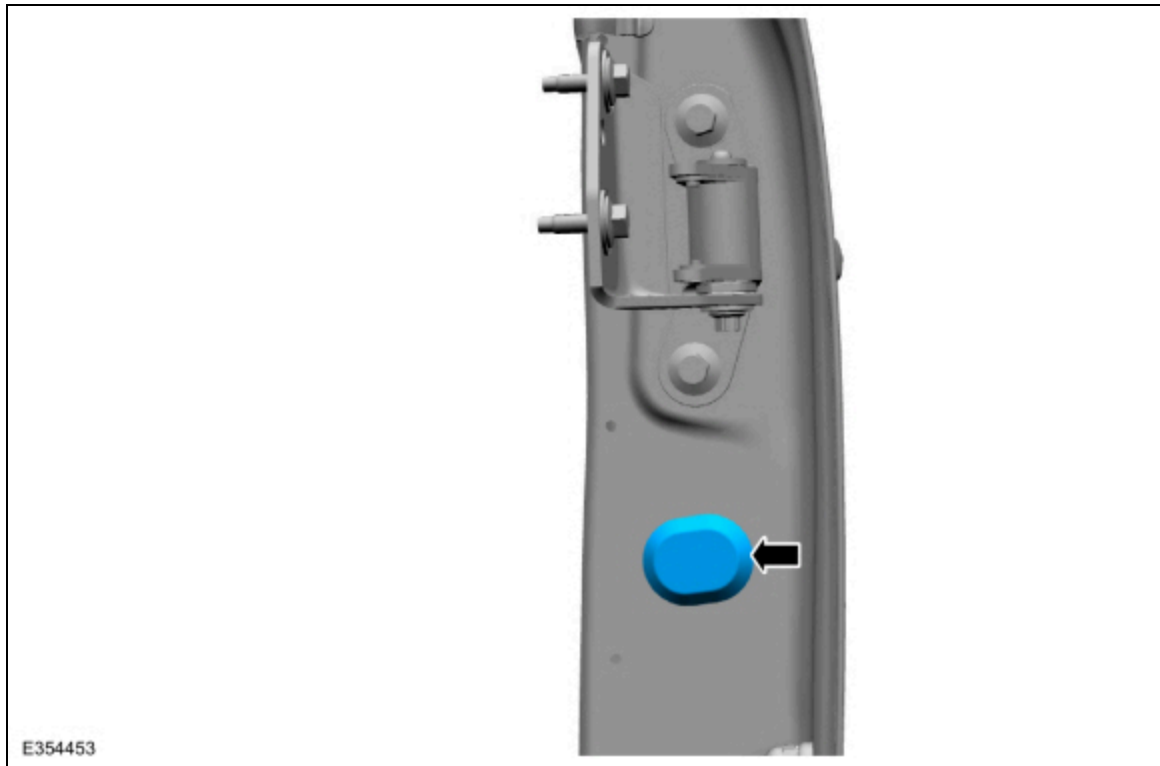

21. **NOTE:** *The front door shown removed for clarity.*

Remove the front door watershield.

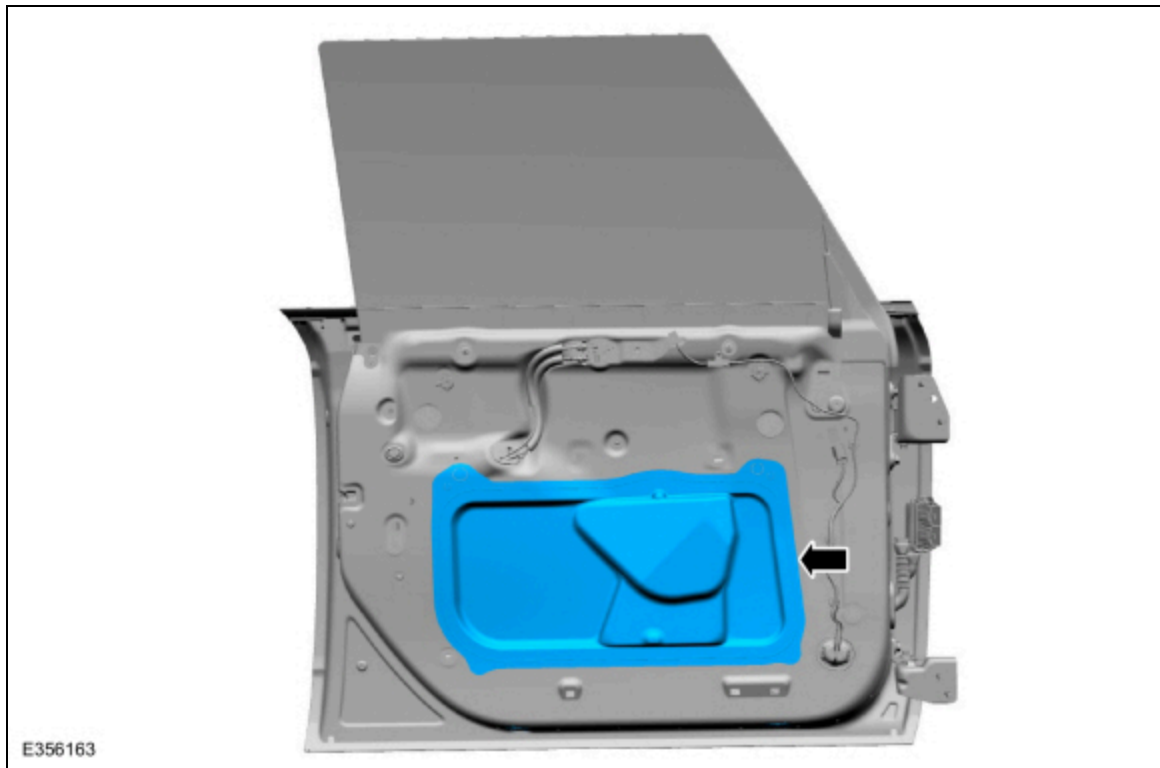

22. **NOTE:** The front door shown removed for clarity.

NOTE: Make sure to mark the location of the lower front door window regulator retainers position to aid alignment as a starting point reference.

Loosen the lower front door window regulator retainers.

1. Mark around the lower front door window regulator retainers with a marker.
2. Loosen the lower front door window regulator retainers.

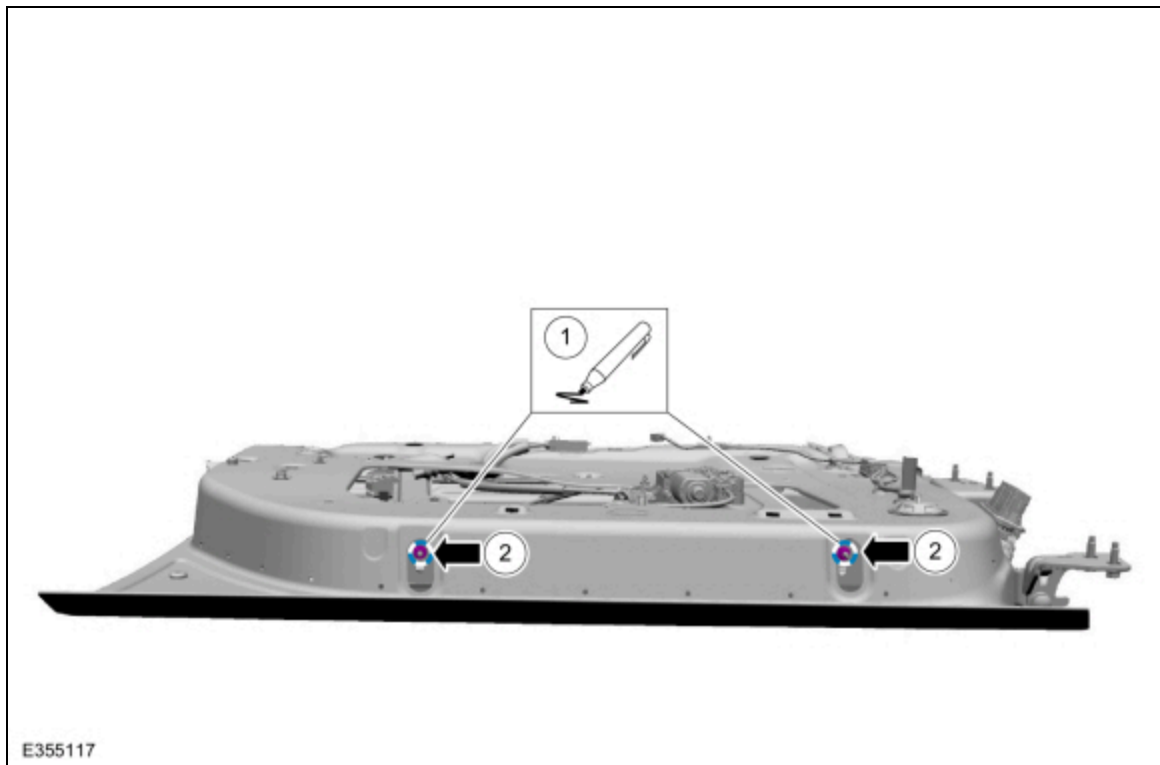

23. **NOTE:** The front door shown removed for clarity.

NOTE: Make sure to mark the location of the rearward front door glass run and bracket lower retainer position to aid alignment as a starting point reference.

Loosen the lower rearward front door glass run and bracket retainer.

1. Mark the location of lower rearward front door glass run and bracket retainer.
2. Loosen the lower rearward front door glass run and bracket retainer.

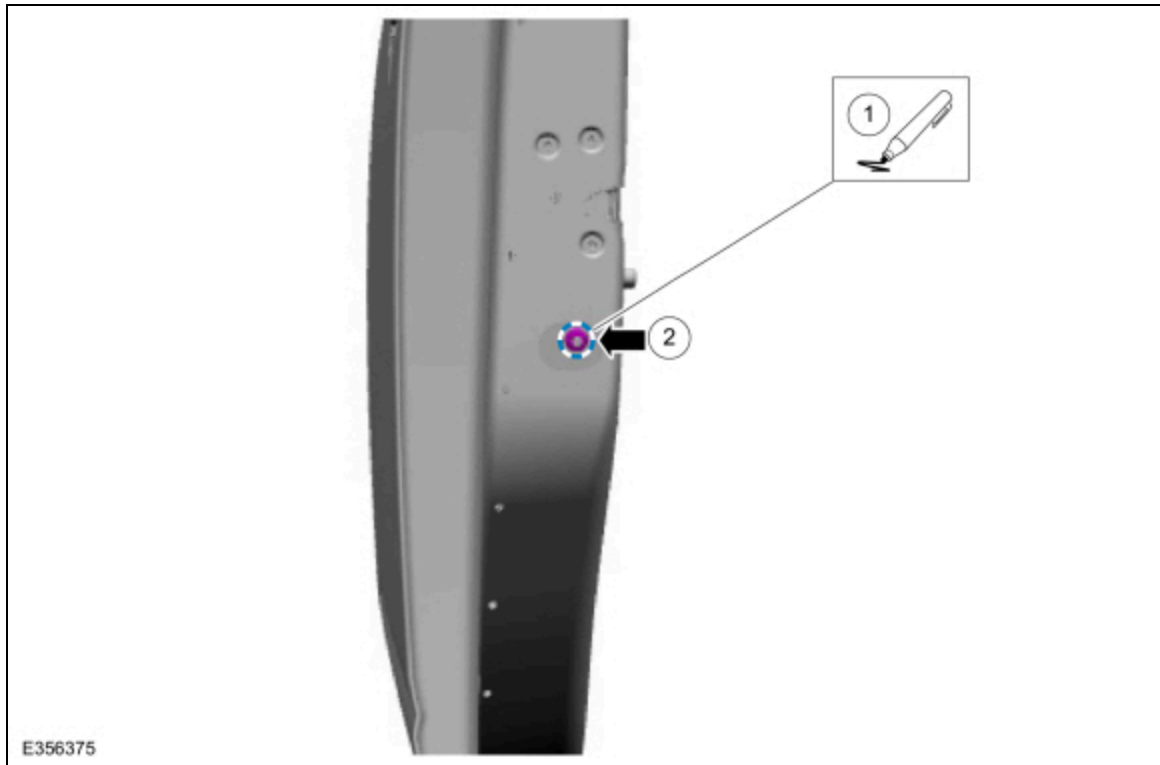

24. **NOTE:** The front door shown removed for clarity.

NOTE: Make sure to mark the location of the forward front door glass run and bracket lower retainer position to aid alignment as a starting point reference.

Loosen the lower forward front door glass run and bracket retainer.

1. Mark the location of forward front door glass run and bracket lower retainer.
2. Loosen the lower forward front door glass run and bracket retainer.

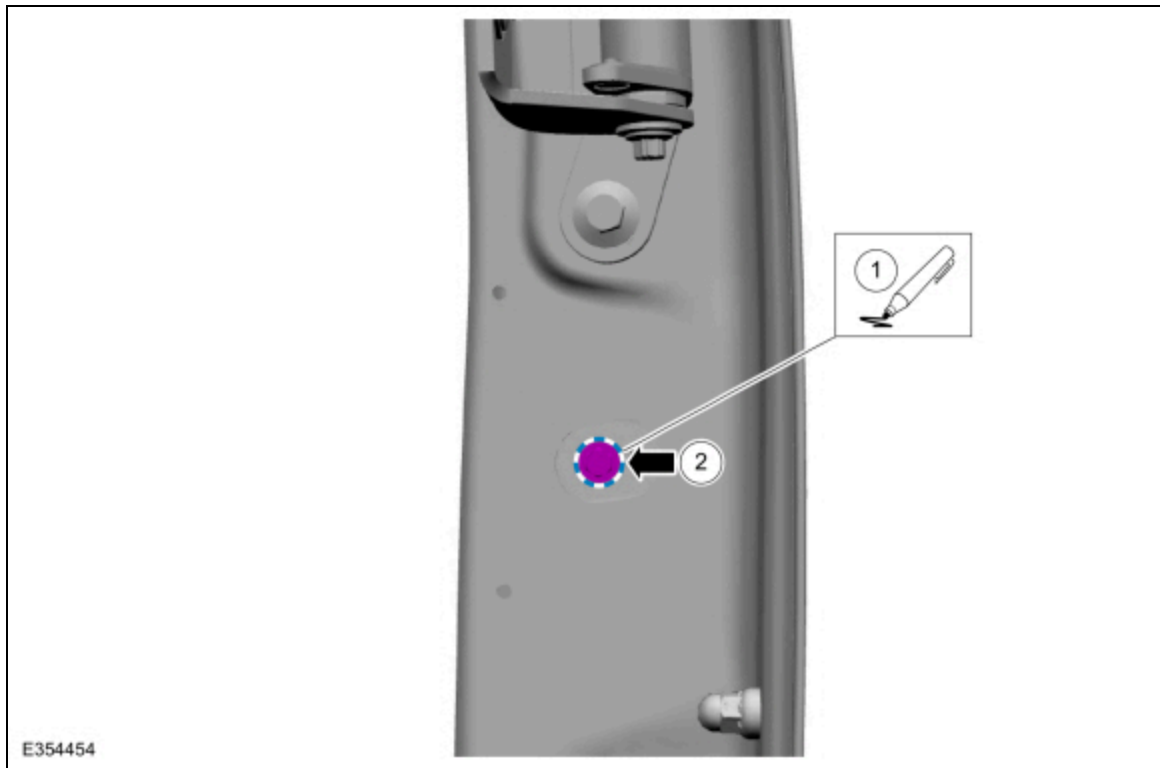

25. **NOTE:** The front door shown removed for clarity.

Lower the front door window glass to the full down position.

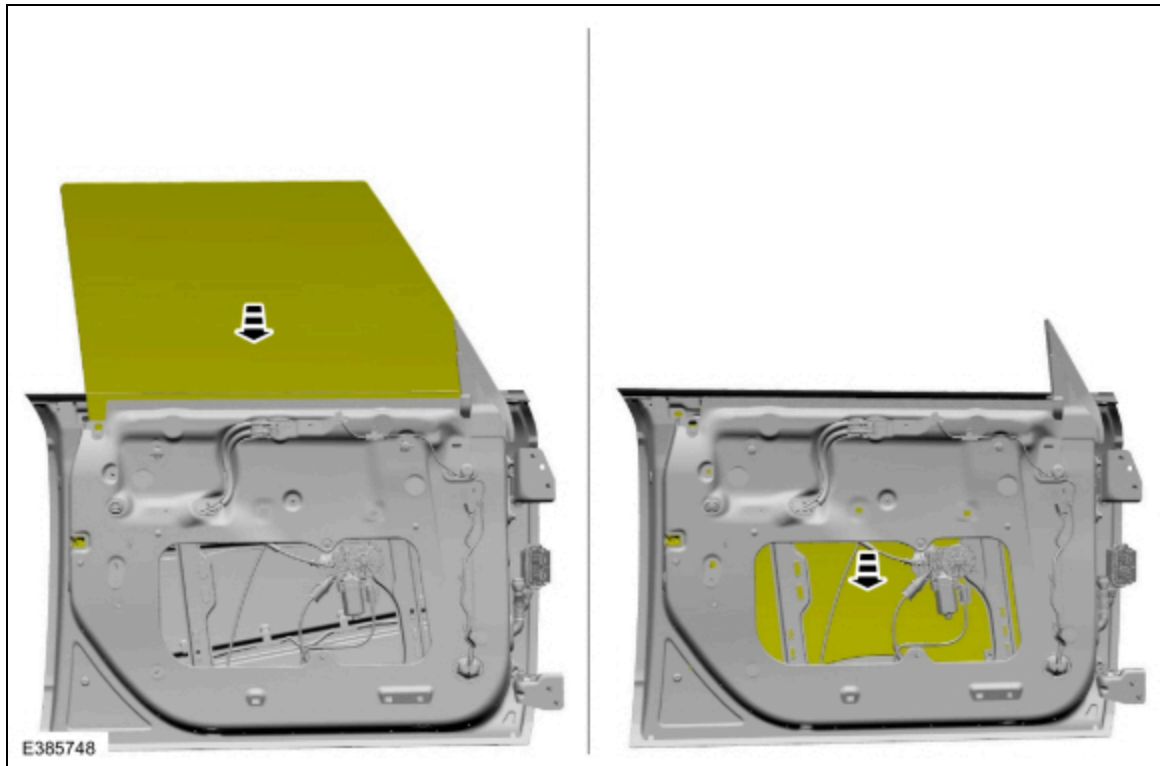

26. **NOTE:** The front door shown removed for clarity.

NOTE: The front door window glass shown removed for clarity.

NOTE: The front door shown transparent for clarity.

NOTE: Adjust the front door window regulator rails equally in and out to avoid binding.

NOTE: Start with front door window regulator rails in the neutral position as starting point reference. Add more or less tip and or out as needed. The neutral state would put the studs about 60% of the way to the outboard side of the door in the adjustment slots.

Adjust the front door window regulator rails to achieve more or less tip in at the top of the front door window glass.

1. Adjust the front and rear regulator rails equally in and out to avoid binding and tighten the lower front door window regulator retainers.

Torque: 71 lb.in (8 Nm)

2. Adjust and tighten the lower forward front door glass run and bracket retainer.

Torque: 71 lb.in (8 Nm)

3. Adjust and tighten the lower rearward front door glass run and bracket retainer.

Torque: 71 lb.in (8 Nm)

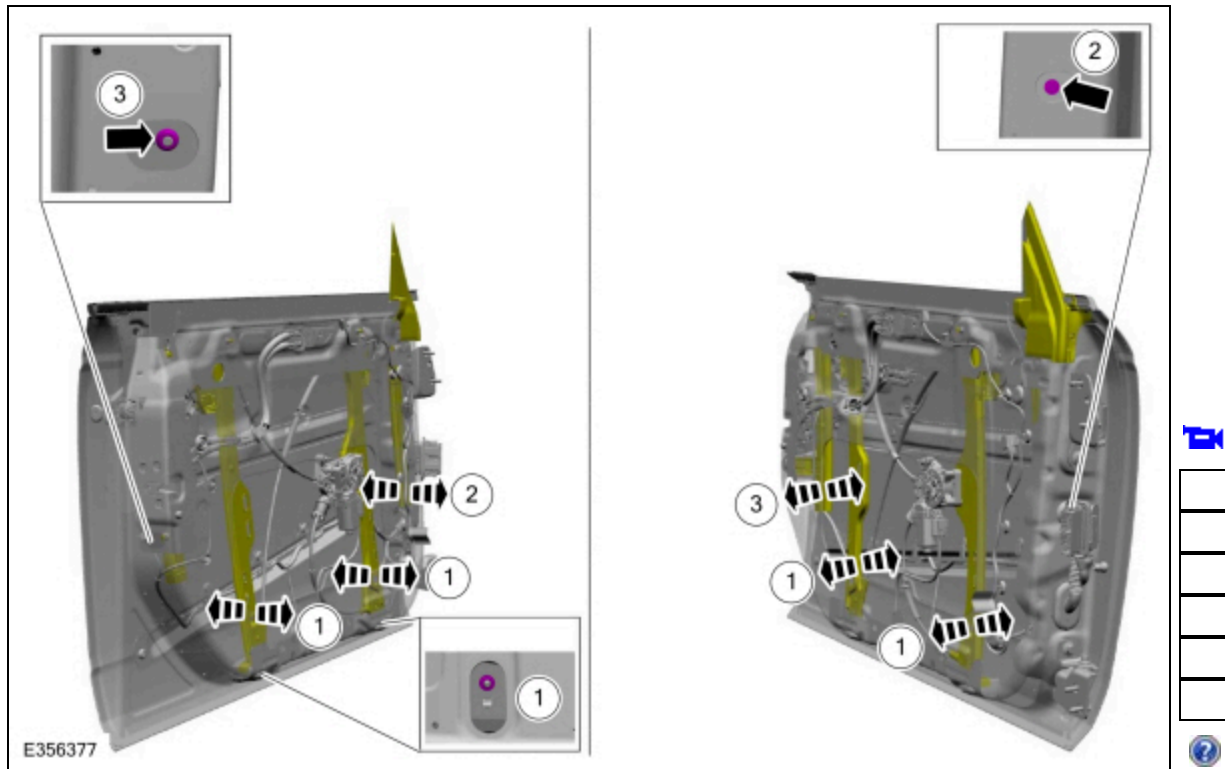

27. **NOTE:** The front door shown removed for clarity.

Raise the front door window glass to the full up position.

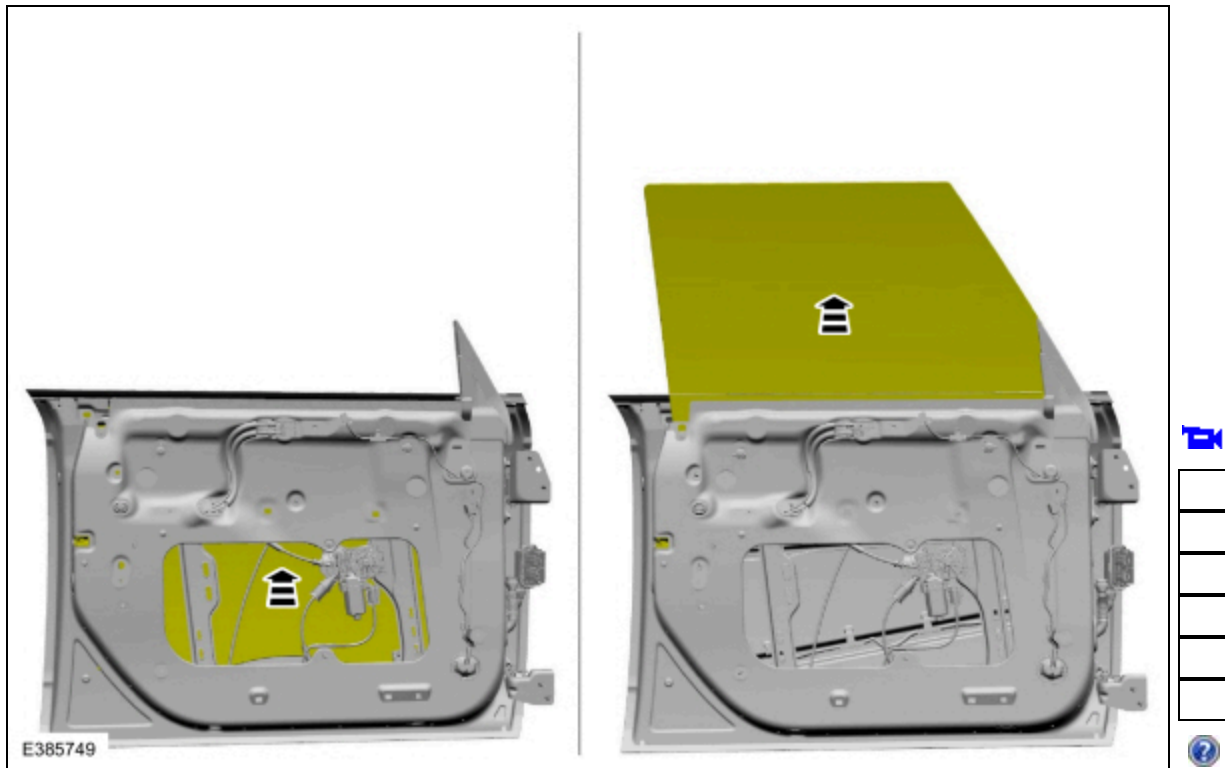

28. Close the front door.

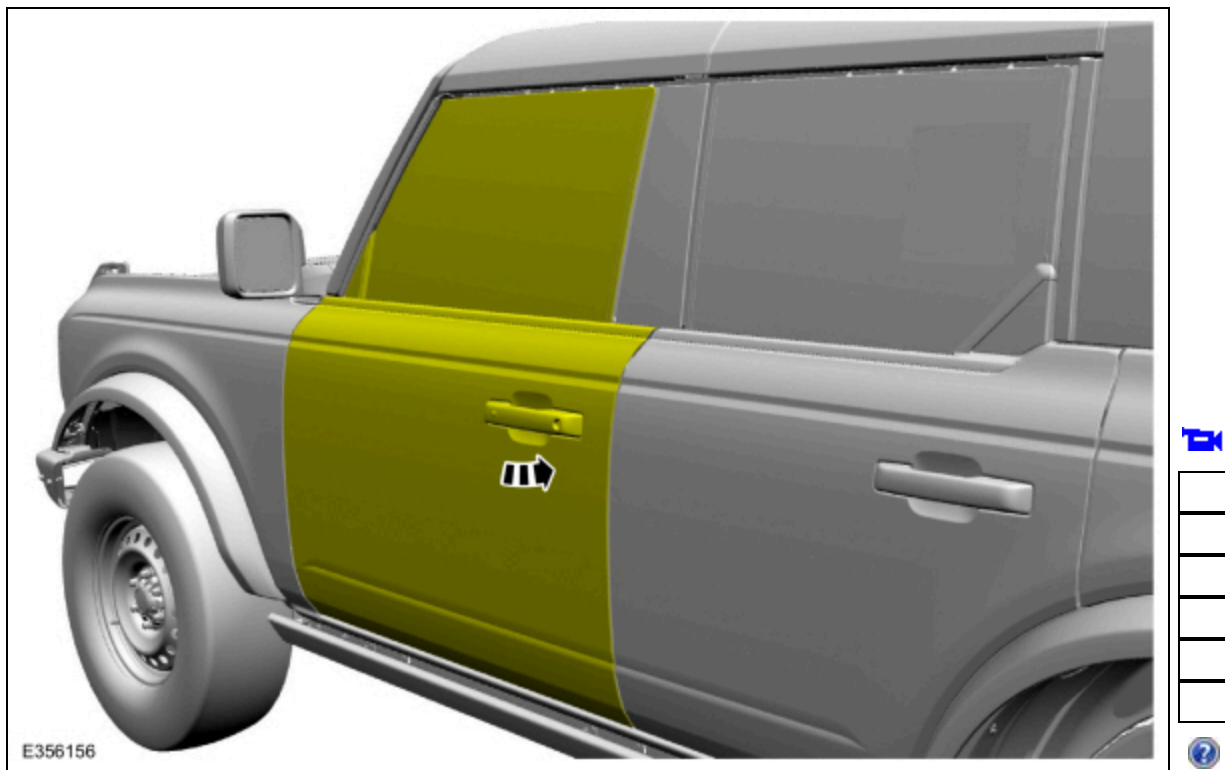

29. **NOTE:** Repeat steps 22 through 27 until the front door window glass within specification.

Lower and raise the front door window glass and check the glass engagement into the weatherstrip at the specified locations.

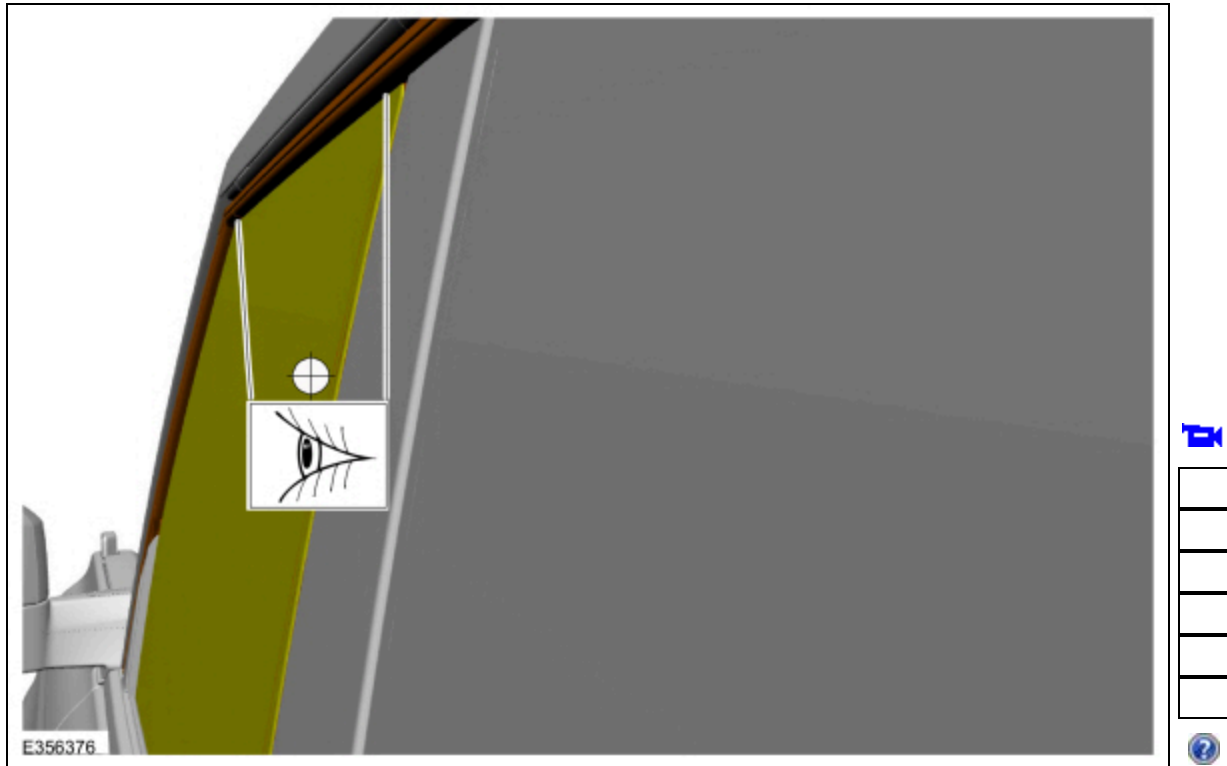

All adjustments

30. Open the front door.

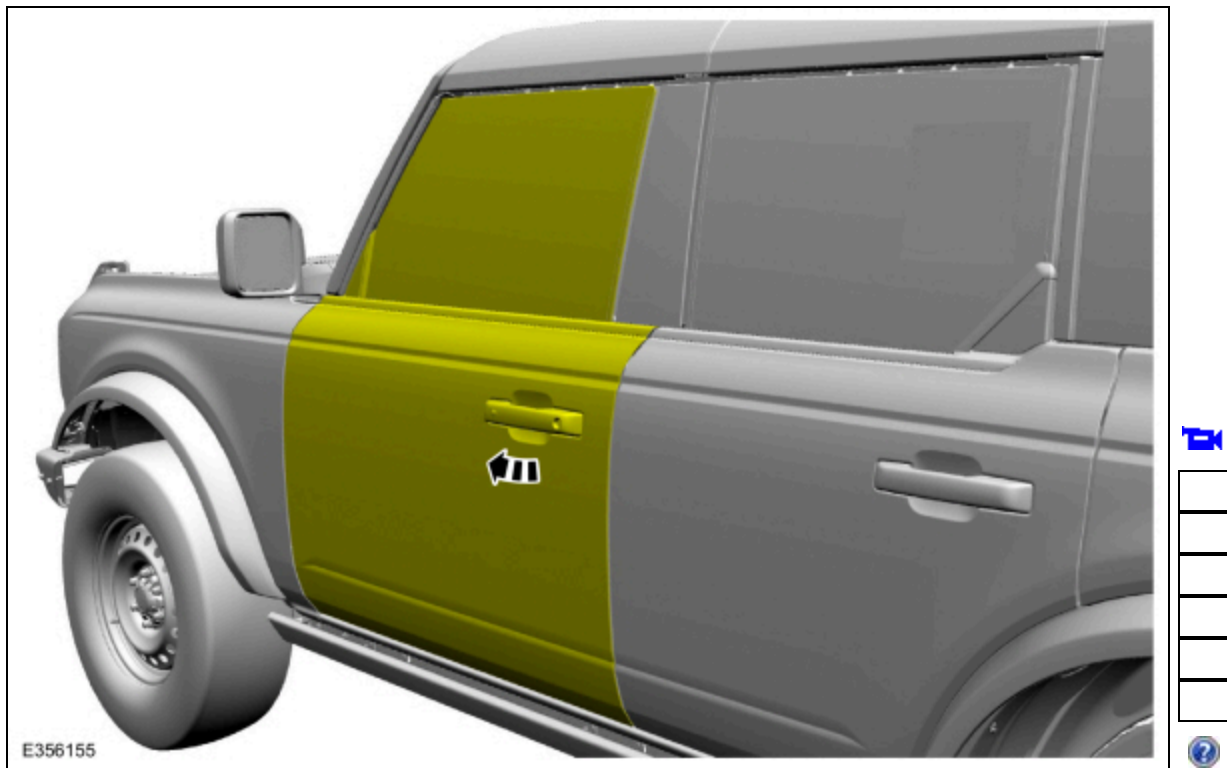

31. **NOTE:** *The front door shown removed for clarity.*

Measure the distance of the marks on the tape at all locations to the top edge of the front door window glass at the specified locations.

1. Measure the front door window glass at the B-pillar 80 mm (3.149 in) from the rear top edge of the front door window glass and record.

2. Measure the front door window glass at the A-pillar 80 mm (3.149 in) from the front top edge of the front door window glass and record.
3. Measure the front door window glass at the A-pillar 40 mm (1.574 in) down from the front top edge of the front door window glass and record.
4. Measure the front door window glass from at the 170 mm (6.692 in) mark from the front top edge of the front door window glass and record.

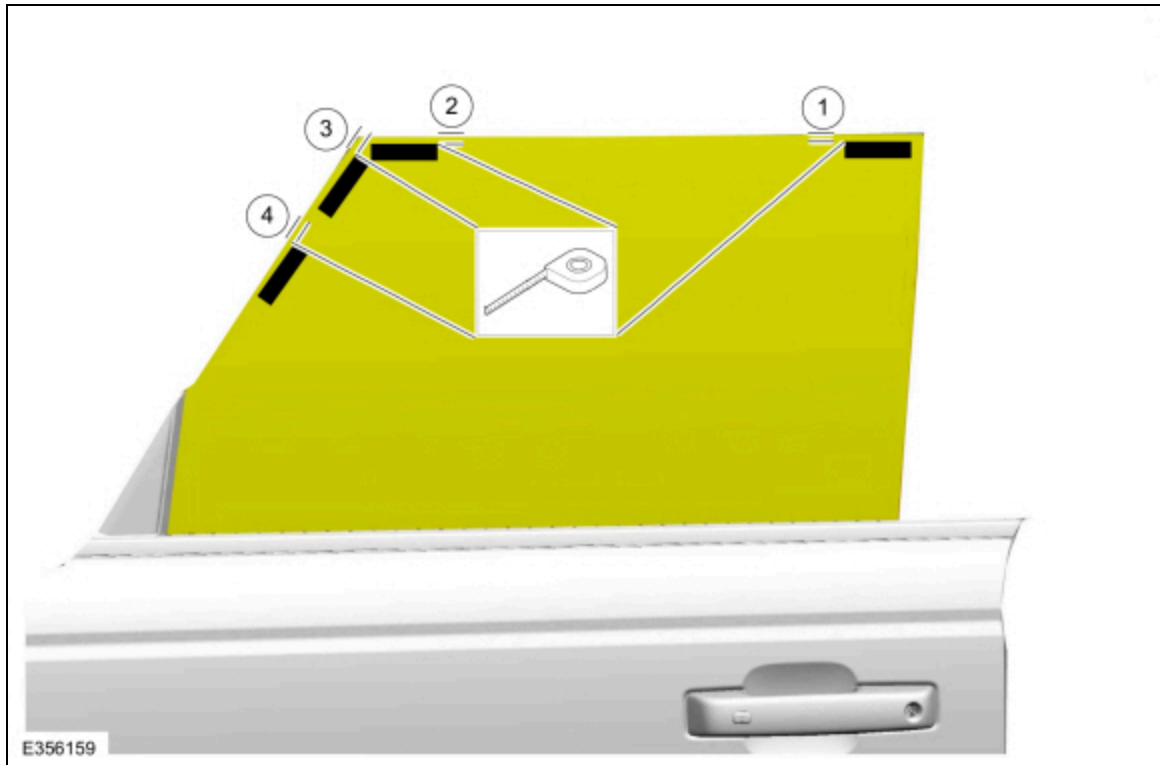

32. Close the front door.

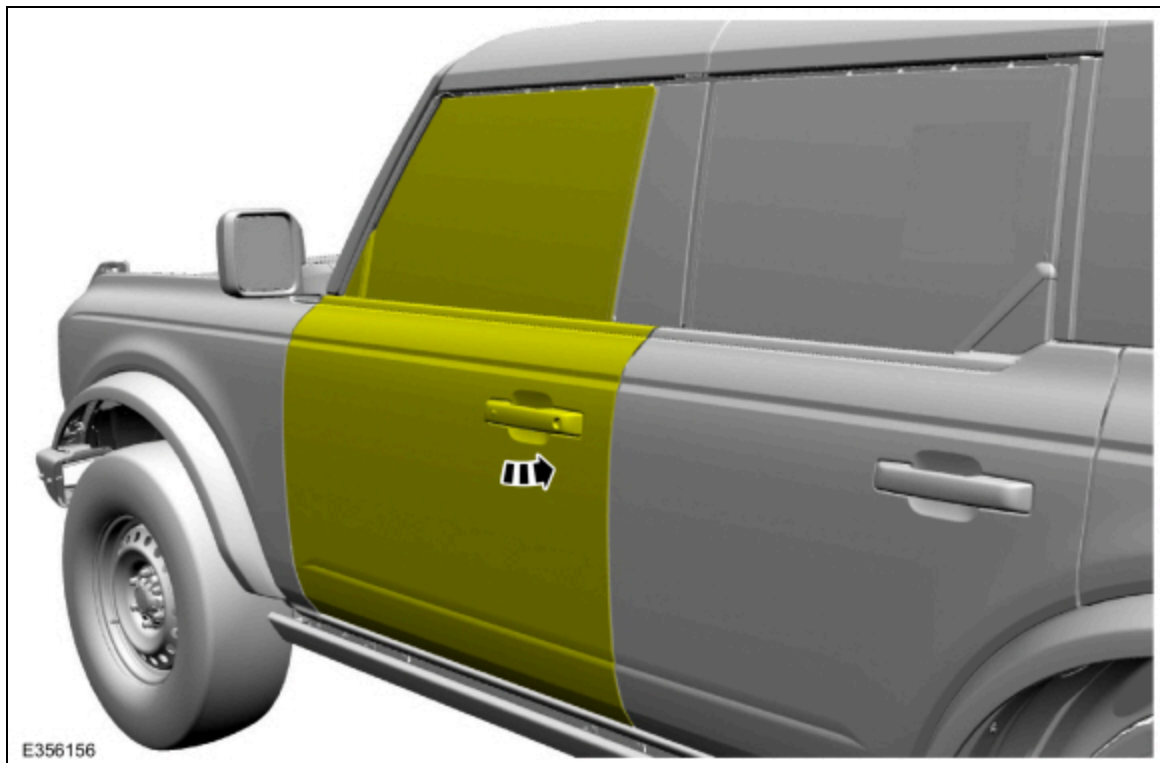

33. Measure the distance of the marks on the tape at all locations to the outer bottom edge of the seal retainer at the specified locations.

1. Measure the front door window glass at the B-pillar 80 mm (3.149 in) from the rear top edge of the front door window glass and record.
2. Measure the front door window glass at the A-pillar 80 mm (3.149 in) from the front top edge of the front door window glass and record.
3. Measure the front door window glass at the A-pillar 40 mm (1.574 in) down from the front top edge of the front door window glass and record.
4. Measure the front door window glass at the 170 mm (6.692 in) mark from the front top edge of the front door window glass and record.

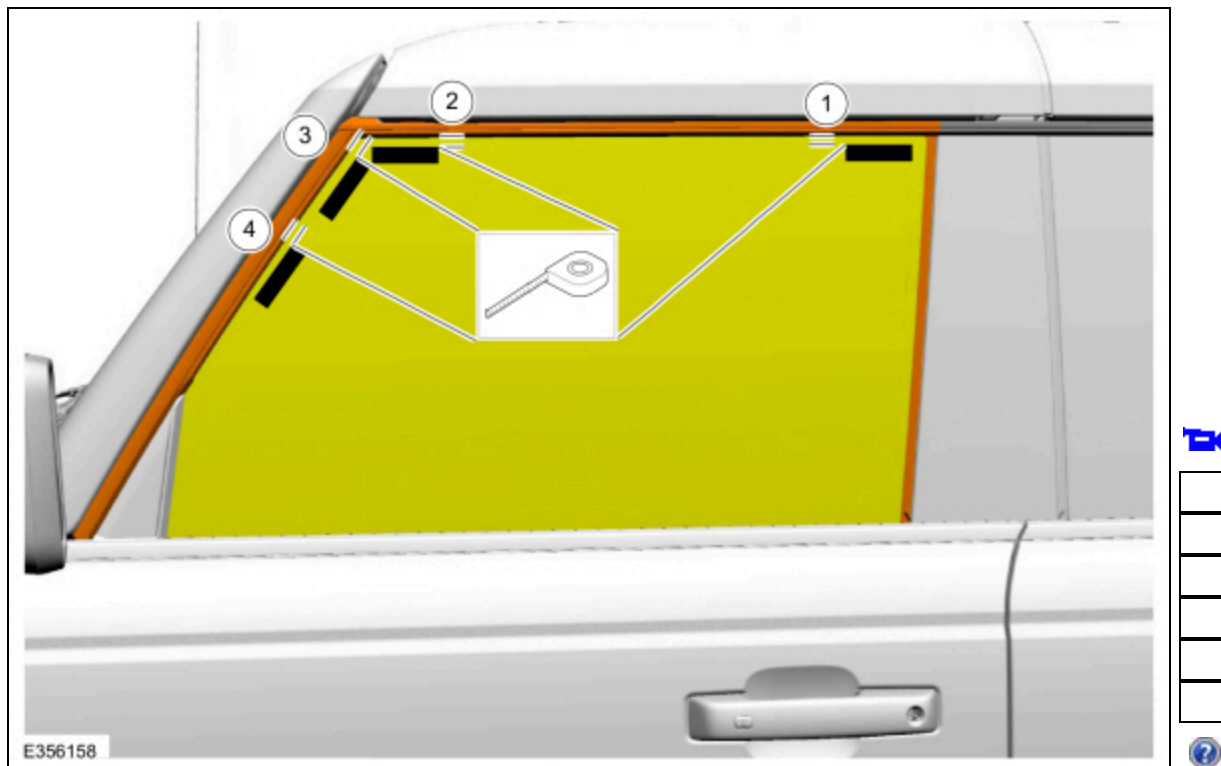

34. **NOTE:** Repeat steps 11 through 15 until the front door window glass within specification.

Subtract the distance of the tape marks on the at all locations from the previously recorded measurements in step 4.

1. Front door window glass engagement measurement range at the B-pillar 80 mm (3.149 in) from the rear top edge of the front door window glass range is 3 mm (0.118) +/-2 mm (0.078 in).
2. Front door window glass engagement measurement range at A-pillar 80 mm (3.149 in) from the front top edge of the front door window glass range is 3 mm (0.118) +/-2 mm (0.078 in).
3. Front door window glass engagement measurement range at the A-pillar 40 mm (1.574 in) down from the front top edge of the front door window glass range is 4 mm (0.157 in) +/-2 mm (0.078 in).
4. Front door window glass engagement measurement range at the 170 mm (6.692 in) range is 4 mm (0.157 in) +/-2 mm (0.078 in).
5. Measure the front door window glass gap between the B-pillar and the rear edge of the front door window glass. When the glass is adjusted correctly the gap should be 10 mm (0.393 in) +/-2.6 mm (0.102 in) the entire length of the rear edge of the front door window glass.

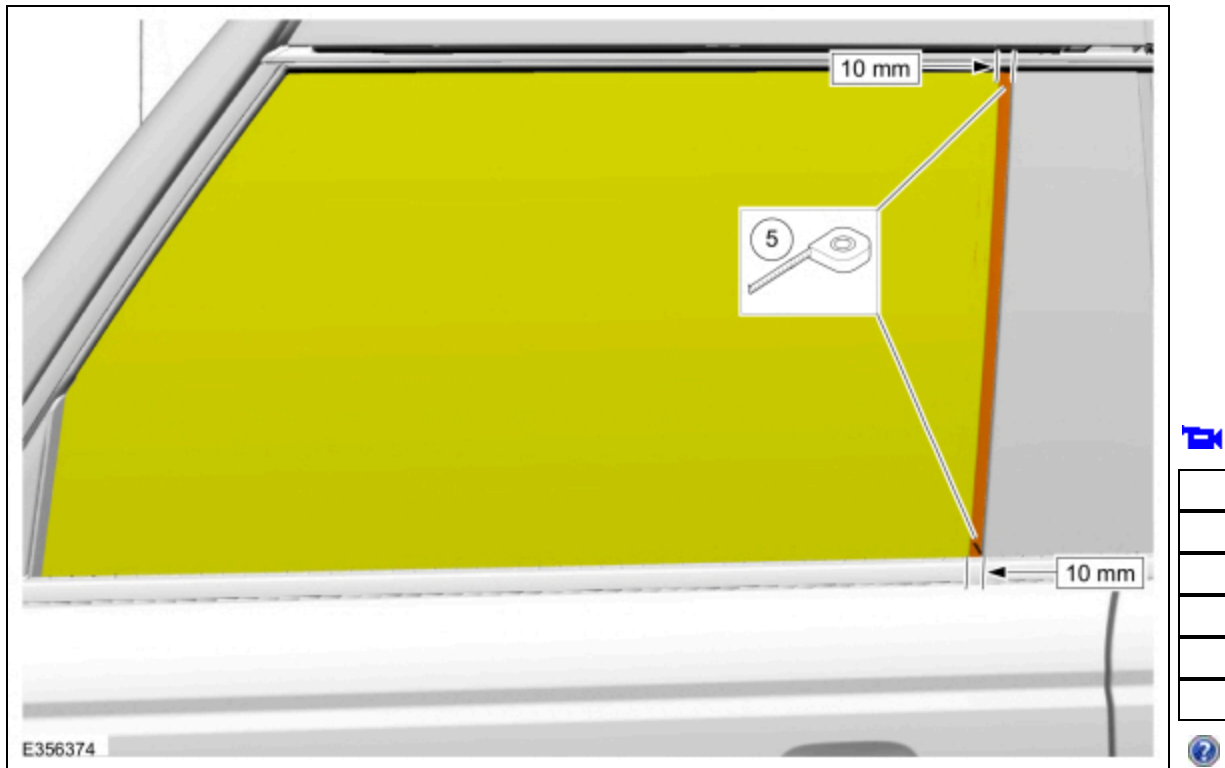

35. **NOTE:** Repeat steps 22 through 27 until the front door window glass within specification.

Lower and raise the front door window glass and check the glass engagement into the weatherstrip at the specified locations.

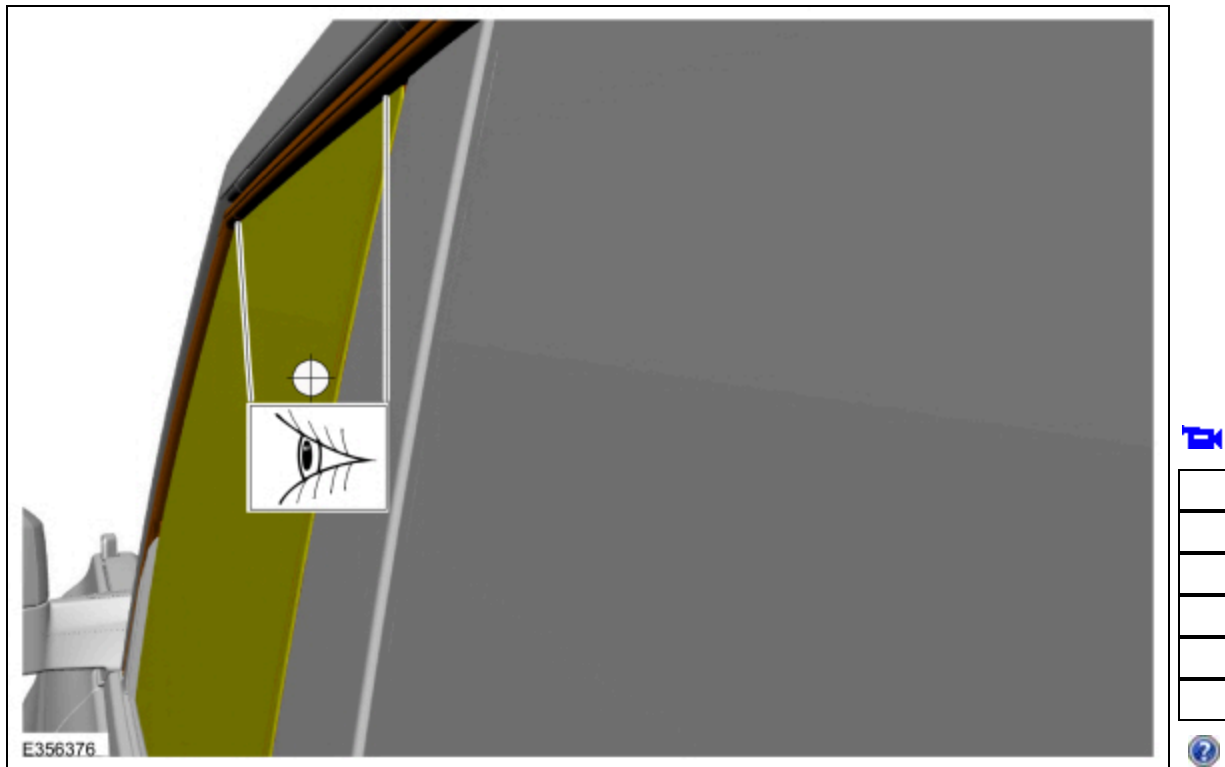

36. Remove the tape from the front door window glass.

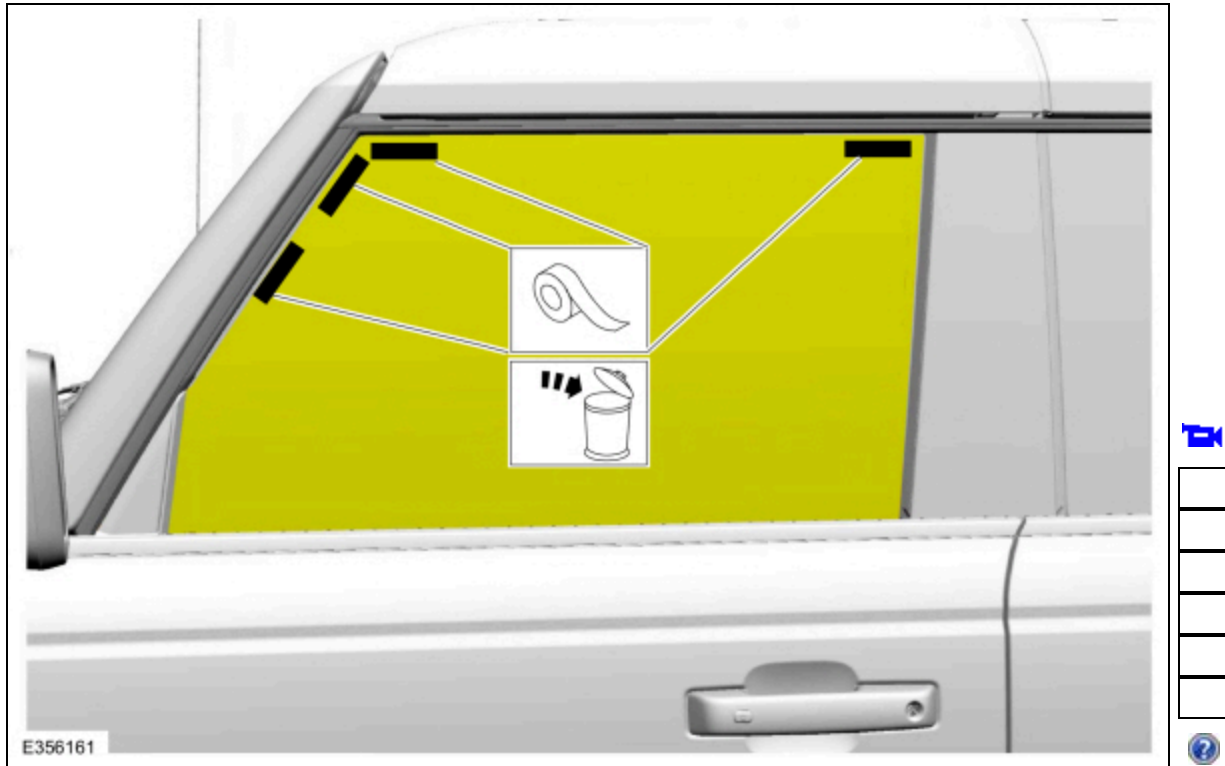

37. Install the removed components.

38. Carry out the power door window initialization.

Refer to: Power Door Window Initialization - Vehicles With: One-Touch Open and Close Front Windows (501-11) .

© Copyright 2025, Ford Motor Company.